

## PRO 76T | MULTIFUNCTIONAL DRILLING MACHINE

PRO 76T is the latest multifunction machine with Morse Taper No. 3 that can perform also tapping jobs thanks to the left and right rotations. The drill is equipped with motor overload protection system and continuous speed adjustment, which works in two speed ranges. Additionally, it has a state of the art Electronic Speed Stabilization System (ESSS), responsible for stabilizing motor's speed under varying loads on the spindle. Its precision and durability are significantly increased thanks to the one gearbox housing and slide.









Unique semi-automatic gib backlash adjustment (Promotech's patent pending) enables simple, fast and correct adjustments without any expert knowledge or experience. Replaceable spline at the end of armature shaft eliminates laborious and expensive armature maintenance. Compact design allows to drill very close to vertical surface.

PRO 76T is equipped with electromagnetic base featuring magnetic field shape control system (MFSC) and magnetic power adhesion control module (MPAC), which detects adhesive force of electromagnetic base and protects both the machine and the operator from work on too thin workpieces.

Standard shipping set of PRO 76T includes MT3 Arbor with 3/4" (19 mm) Weldon Bore that accepts cutters up to 60 mm (2-5/16") diameter. Optional MT3 Arbor with 1-1/4" (32 mm) Weldon Bore for cutters of larger diameters is available.

PRO 76T can also be ordered with a swivel base as PRO 76T+.



-   
 Core drill  
max 76 mm
-   
 Twist drill  
max 32 mm
-   
 Spindle  
MT3
-   
 Depth of cut  
76 mm
-   
 Stroke  
225 mm
-   
 Speed 80-160,  
210-420 rpm
-   
 Motor Power  
1650 W
-   
 Weight  
27 kg
-   
 Thread cutting  
M24



Max  
Ø 76 mm  
(3")



Max  
Ø 32 mm  
(1-1/4")



Max  
Ø 63 mm  
(2-1/2")



Max  
M24  
(G 3/4")

### PRO 76T - TECHNICAL SPECIFICATION

Motor Speeds (under load)	80 ÷ 160; 210 ÷ 420 rpm
Motor Power	1650 W
Weight	27 kg (58 lbs 4 oz)
Max milling capacity	Ø 76 mm (3")
Max drilling capacity	Ø 32 mm (1-1/4")
Max countersinking	Ø 63 mm (2-1/2")
Max Tap size	M24 (G 3/4")
Stroke	225 mm (8-7/8")
Max depth of cut	76 mm (3")
Voltage	1~ 110–120 V, 50–60 Hz 1~ 220–240 V, 50–60 Hz
Power consumption	1800 W
Overload protection	yes
ESSS (Electronic Speed Stabilization System)	yes
Continuous Speed Adjustment	yes
Semi-automatic gib adjustment	yes
MPAC (Magnetic Power Adhesion Control)	yes
MFSC (Magnetic Field Shape Control)	yes
Magnetic clamping force	1988 kG (19500 N) /25 mm, Ra=1,25/
Magnet Base Dimensions	110 x 220 x 56 mm; (4-5/16 x 8-11/16 x 2-3/16")
Swivel base (PRO76T+)	± 15°; ± 15 mm (± 9/16")
Min. Workpiece Thickness	10 mm (3/8")
Spindle	MT3
Tool holder	19 mm (3/4") Weldon
Product Code 220–240 V, 50–60 Hz	WRT-0473-10-20-00-0
Product Code 220–240 V, 50–60 Hz w. swivel base	WRT-0473-10-20-00-1
Product Code 110–120 V, 50–60 Hz	WRT-0473-10-10-00-0
Product Code 110–120 V, 50–60 Hz w. swivel base	WRT-0473-10-10-00-1

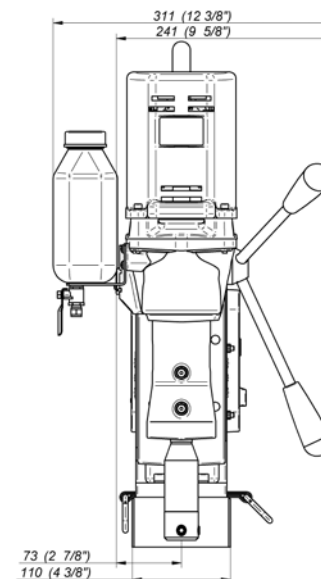
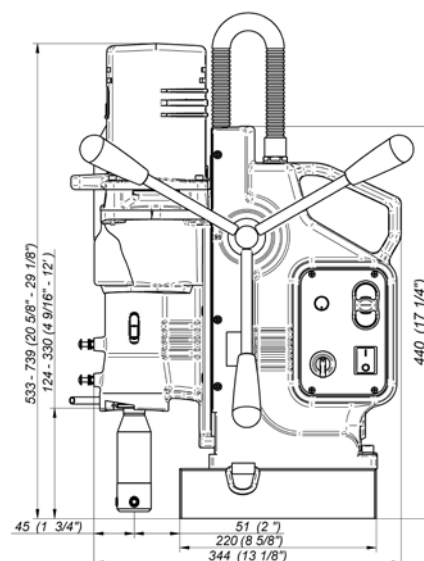

#### Standard shipping set:

- Magnetic Base Drilling Machine
- Metal Box
- MT3 Arbor with 19 mm Bore - Through Spindle Continuous Cooling
- Swarf Shield/Cutter Guard
- Coolant Bottle Assembly, Safety Chain with Snap Hook, Set of Tools with Wedge
- Operator's Manual (English)
- Standard shipping weight - 40 kg (86 lbs 5 oz)

#### Selected additional accessories:

- UCW-0191-00-00-00-0 Through Spindle Continuous Cooling Arbor MT3-32 Weldon Bore
- UCW-0285-03-00-02-0 Quick Change Continuous Cooling Arbor MT3- 19 Weldon
- PDS-0111-03-00-01-0 DMP0501 Pipe Attachment
- UKL-0440-16-00-00-0 Pressure Coolant System 21



Swivel base in version PRO 76T+



PROMOTECH Sp. z o.o.  
ul. Elewatorska 23/1, 15-620 BIAŁYSTOK, POLAND  
tel. (+48 85) 678 34 05, fax (+48 85) 662 78 77  
marketing@promotech.eu www.promotech.eu

Your local dealer:

